



MAGNETIC LIGHT

GRAVITY RECESSED

GRAVITY SURFACE

GRAVITY HANG





Magnetica Profiles System

Magnetically absorbed lighting system can combine your lighting products at will according to lighting needs.

It can match floodlight lighting, key line lighting, hanging line decoration lighting, adjustable angle key lighting and wall washing lighting.

- 1 Supporting the original system lamp scheme developed by the Nine National Congresses, covering all space applications from point, line and surface, realizing the design of no main lamp.
- 2 Magnetic design for changing without any tools.
- 3 Sustainable Extension of Functional Plates.

MAGNETIC LIGHT

GRAVITY FOCUS



GRAVITY BALL

GRAVITY GLOBE

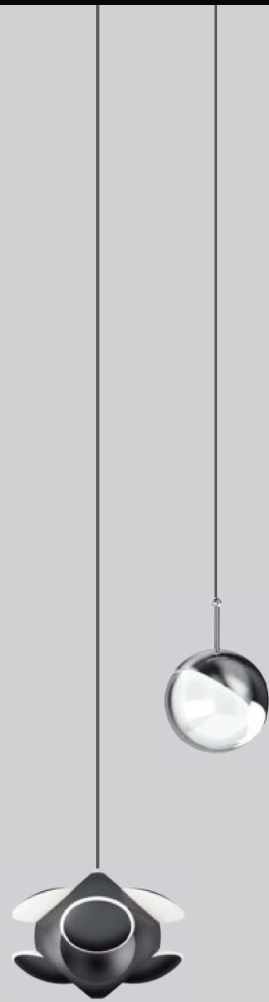

More Modules Combination Available

Linear System with more modules combination available.
All available with Suspended, surface mounted and recessed mounted versions.

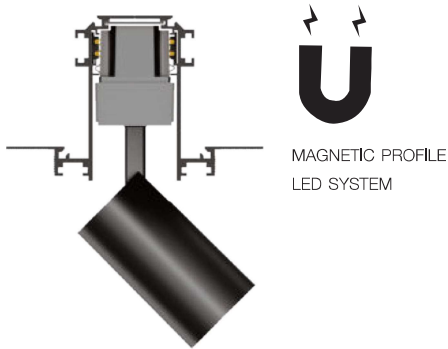

Magnet Attachment

Different insets are held in place by magnetic force along the entire track. No tools are needed to install them, Rotate, slide into any position, and adjust at any time—all it takes is one hand movement to highlight objects according to requirements.



SURFACE PENDANT

GRAVITY HANG

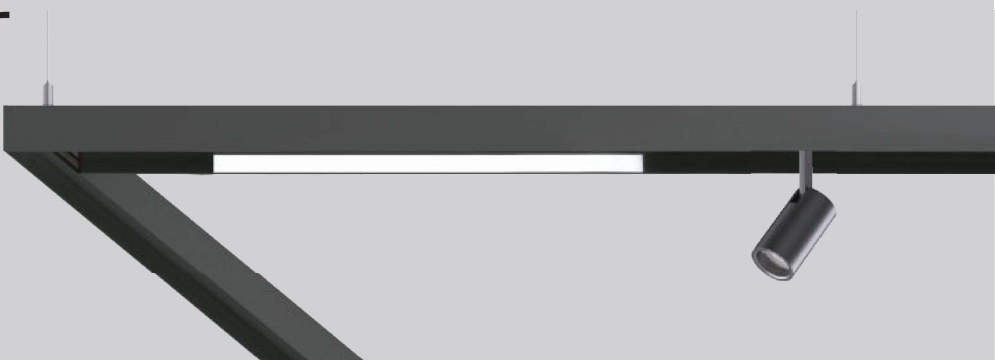

SPECIFICATION

			
MODEL	L CORNER	L CORNER OUTER	L CORNER INNER
SIZE	120 x 52.5mm	120 x 52.5mm	120 x 52.5mm
PRICE	400 Baht	400 Baht	400 Baht
			
MODEL	END CAPS	FEED CONNECTOR	STRAIGHT CONNECTOR
SIZE	52 x 26.5 mm	78 x 18 x 16 mm	100 mm
PRICE	80 Baht	280 Baht	40 Baht
			
MODEL	FEED IN CONNECTOR	HANGING CABLE	RAIL FIXTURE PART
SIZE	144 x 18 x 16 mm	114 x 80 mm	100 x 18 mm
PRICE	220 Baht	330 Baht	70 Baht

- PRICE
- 1000 x 26.6 x 52.5 mm : 1,250 Baht
 - 1500 x 26.6 x 52.5 mm : 1,550 Baht
 - 2000 x 26.6 x 52.5 mm : 1,950 Baht
- COLOR : ●

DIMENSION

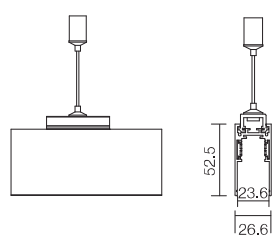

TRIMLESS RECESSED GRAVITY RECESSED

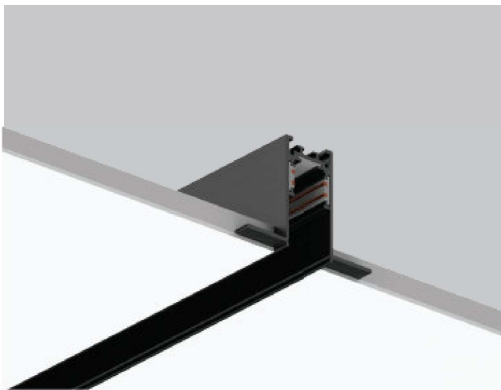

SPECIFICATION

			
MODEL	L CORNER	L CORNER OUTER	L CORNER INNER
SIZE	120 x 52,5mm	120 x 52,5mm	120 x 52,5mm
PRICE	500 Baht	500 Baht	500 Baht
			
MODEL	END CAPS	FEED CONNECTOR	FEED IN CONNECTOR
SIZE	52 x 26,5 mm	78 x 18 x 16 mm	144 x 18 x 16mm
PRICE	80 Baht	280 Baht	220 Baht

PRICE

1000 x 70 x 52.5 mm	:	890 Baht
1500 x 70 x 52.5 mm	:	1,350 Baht
2000 x 70 x 52.5 mm	:	1,760 Baht
COLOR	:	●

DIMENSION

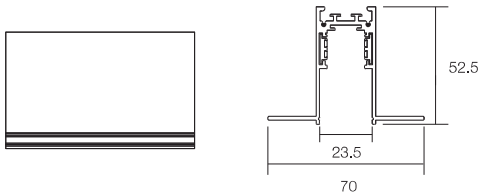

SURFACE MOUNTED

GRAVITY SURFACE



SPECIFICATION

			
MODEL	L CORNER	L CORNER OUTER	L CORNER INNER
SIZE	120 x 52.5 mm	120 x 52.5 mm	120 x 52.5 mm
PRICE	400 Baht	400 Baht	400 Baht
			
MODEL	END CAPS	FEED CONNECTOR	FEED IN CONNECTOR
SIZE	52 x 26.5 mm	78 x 18 x 16 mm	144 x 18 x 16 mm
PRICE	80 Baht	280 Baht	220 Baht

PRICE

1000 x 26.6 x 52.5 mm	:	750	Baht
1500 x 26.6 x 52.5 mm	:	1,100	Baht
2000 x 26.6 x 52.5 mm	:	1,450	Baht
COLOR	:	●	

DIMENSION

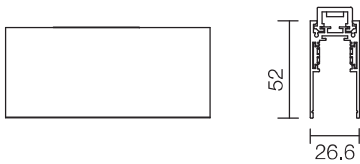

GRAVITY SPOT



GRAVITY SPOT-A

POWER	:	6W
LUMEN	:	450 lm
CCT	:	2700K/3000K/4000K/5000K
CRI	:	>80
BEAM ANGLE	:	15°/24°/36°
DRIVER LED	:	48VDC
COLOR	:	●
PRICE	:	990 Baht



GRAVITY SPOT-B

POWER	:	12W
LUMEN	:	900 lm
CCT	:	2700K/3000K/4000K/5000K
CRI	:	>80
BEAM ANGLE	:	15°/24°/36°
DRIVER LED	:	48VDC
COLOR	:	●
PRICE	:	1,200 Baht

PHOTOMETRIC

Beam Angle 15° 6W 3000K

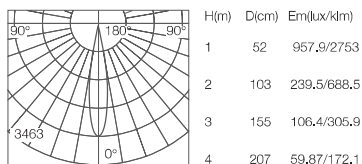

Beam Angle 24° 6W 3000K

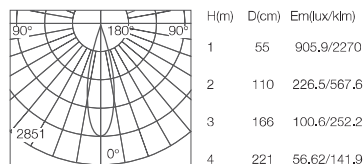

Beam Angle 36° 6W 3000K

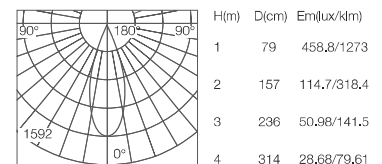

GRAVITY FOCUS

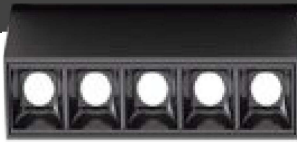

GRAVITY FOCUS-A



GRAVITY FOCUS-B

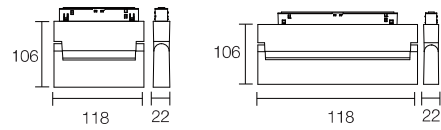

GRAVITY FOCUS-A

POWER	:	6W
LUMEN	:	1380 lm
CCT	:	2700K/3000K/4000K/5000K
CRI	:	>80
BEAM ANGLE	:	12°/24°/38°
DRIVER LED	:	48VDC
COLOR	:	●
PRICE	:	1,250 Baht



GRAVITY FOCUS-B

POWER	:	12W
LUMEN	:	1500 lm
CCT	:	2700K/3000K/4000K/5000K
CRI	:	>80
BEAM ANGLE	:	12°/24°/38°
DRIVER LED	:	48VDC
COLOR	:	●
PRICE	:	1,900 Baht

Beam Angle 12° 12W 3000K

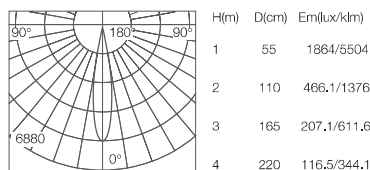

Beam Angle 24° 12W 3000K

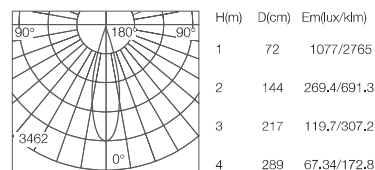

Beam Angle 38° 12W 3000K

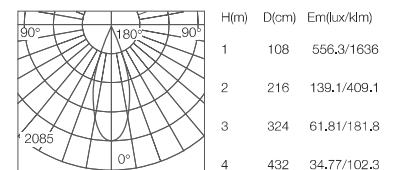



GRAVITY GRILL

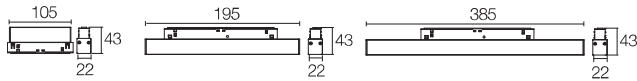

GRAVITY LINE

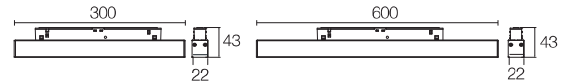

GRAVITY GRILL

- POWER : 6W / 12W / 24W
- LUMEN : 1050 lm / 1875 lm / 2250 lm
- CCT : 2700K/3000K/4000K/5000K
- CRI : >80
- BEAM ANGLE : 30°
- DRIVER LED : 48VDC
- COLOR : ●
- PRICE : 6W / 750 Baht
- : 12W / 890 Baht
- : 24W / 1,500 Baht



GRAVITY LINE

- POWER : 10W / 20W
- LUMEN : 920 lm / 1840 lm
- CCT : 2700K/3000K/4000K/5000K
- CRI : >80
- BEAM ANGLE : 120°
- DRIVER LED : 48VDC
- COLOR : ●
- PRICE : 10W / 700 Baht
- : 20W / 1,000 Baht

Beam Angle 12° 12W 3000K

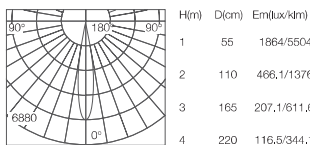

Beam Angle 24° 12W 3000K

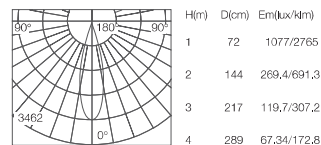

Beam Angle 38° 12W 3000K

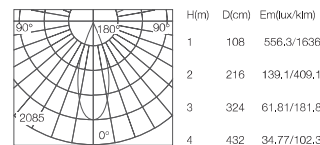

Beam Angle 120° 20W 3000K

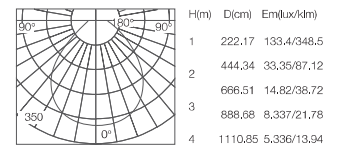

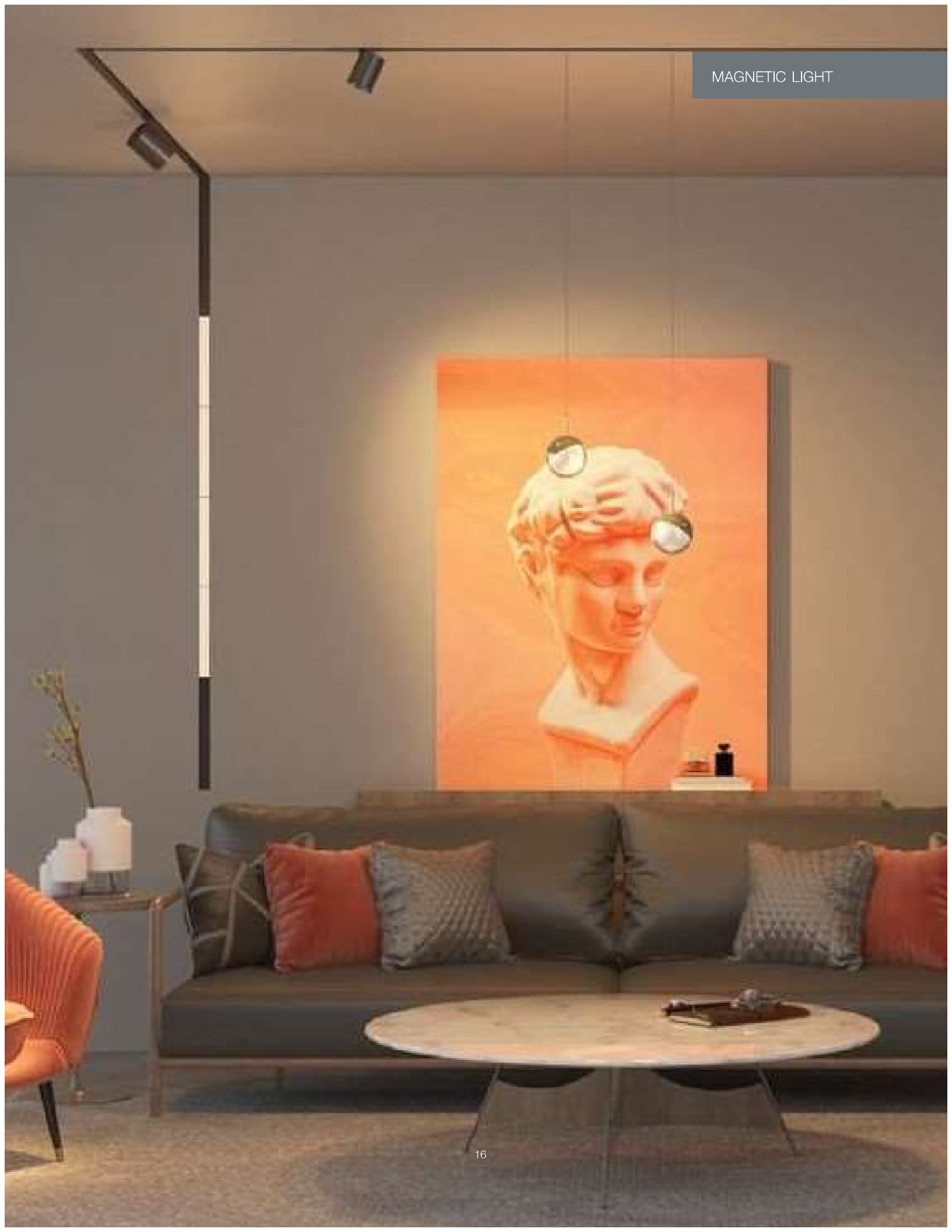

MAGNETIC LIGHT



GRAVITY GLOBE



GRAVITY BALL



GRAVITY TUBE

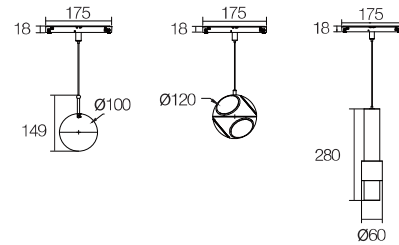

GRAVITY GLOBE

POWER : 6W
 LUMEN : 540 lm
 CCT : 2700K/3000K/4000K/5000K
 CRI : >80
 DRIVER LED : 48VDC
 COLOR : ●
 PRICE : 2,000 Baht

GRAVITY BALL

POWER : 6W
 LUMEN : 480 lm
 CCT : 2700K/3000K/4000K/5000K
 CRI : >80
 DRIVER LED : 48VDC
 COLOR : ●
 PRICE : 2,650 Baht

GRAVITY TUBE

POWER : 8W
 LUMEN : 560 lm
 CCT : 2700K/3000K/4000K/5000K
 CRI : >80
 BEAM ANGLE : 25°/40°/60°/80°
 DRIVER LED : 48VDC
 COLOR : ●
 PRICE : 2,250 Baht

Instructions for Remote Control



GRAVITY GATEWAY

PRICE : 2,500 Baht



GRAVITY TOUCH PANEL

PRICE : 2,390 Baht

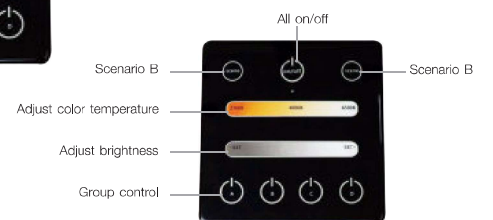

MAGNETIC LIGHT



L CORNER OUTER



FEED CONNECTOR

Flat angle, internal angle, and external angle are also applicable



48V Safe Voltage Modular Linear System

Gravity magnetic Rail has 26.60 mm side four-wire 2-loop Guide.

- Suitable for surface mounted or suspended with 1000mm steel cable.
- Track Rail available with standard lengths 1000mm ,1500mm and 2000mm.
- 'L' shape corner module available for flexible system.
- Linear Connector and Continuous Kit provided for continuous Track Rail connection.
- Insets available with Non Dim and 1-10V Dim.
- Various lighting insets with multiple lighting applications, Tool-free insert mounting by clip-in mechanism.